



SURVIVALINK AED[®]

automated external defibrillator

OPERATION
&
SERVICE
MANUAL



9200/9210



9100/9110



CARDIAC SCIENCE





CARDIAC SCIENCE

5 Year Limited Warranty

What is Covered?

Cardiac Science, Inc. (Cardiac Science) warrants to the original purchaser that its products will be free of any defect in material and workmanship according to the terms and conditions of this Five year Limited Warranty. For purposes of this Limited Warranty, the original purchaser is deemed to be the original end user of the product purchased. This Limited Warranty is NONTRANSFERABLE and UNASSIGNABLE.

For How Long?

Five (5) years from the date of original shipment to original purchaser for all products except those with a date expiration (electrodes and lead acid batteries) and lithium batteries. Products with a date expiration shall be warranted until the expiration date. Lithium batteries shall be warranted a shelf life of Five (5) years from date of shipment. Lithium batteries shall be warranted for an operating life of Two (2) years from the date of installation into a Cardiac Science AED. The terms of the Limited Warranty in effect as of the date of original purchase will apply to any warranty claims.

What You Must Do

To qualify for this Limited Warranty, the original purchaser must send the completed Warranty Validation Card within 30 days of original shipment to Cardiac Science, Inc., 5420 Feltl Road, Minneapolis, Minnesota 55343.

To obtain warranty service for your product, call us toll free at (800) 991-5465, or (952) 939-4181 seven days a week, 24 hours a day. Our technical service representative will try to resolve your issue over the phone. If necessary, and in our sole discretion, we will arrange for service or a replacement of our product.

What We Will Do

If your Cardiac Science product contains defects in material or workmanship, and is returned within 30 days of the date it was purchased, at the direction of a technical service representative, we will replace it with a new product of equal value at no charge to you, provided the warranty applies.

If your Cardiac Science product contains defects in material or workmanship and is returned, at the direction of a technical service representative, after 30 days but within the warranty period, Cardiac Science, at its sole discretion, will repair your product or replace it with a new or reconditioned product of the same or similar design. The repaired or replacement product will be warranted subject to the terms and conditions of this Limited Warranty for either (a) 90 days or (b) the remainder of the original warranty period, whichever is longer, provided the warranty applies and the warranty period has not expired.

Obligations and Warranty Limits

Limited Warranty Obligation: Exclusive Remedy

THE FOREGOING LIMITED WARRANTY IS IN LIEU OF AND SPECIFICALLY EXCLUDES AND REPLACES ALL OTHER EXPRESS OR IMPLIED WARRANTIES, INCLUDING BUT NOT LIMITED TO THE IMPLIED WARRANTIES OF MERCHANTABILITY AND FITNESS FOR A PARTICULAR PURPOSE.

Some states do not allow limitations on how long an implied warranty lasts, so this limitation may not apply to you.

NO PERSON (INCLUDING ANY AGENT, DEALER, OR REPRESENTATIVE OF CARDIAC SCIENCE) IS AUTHORIZED TO MAKE ANY REPRESENTATION OR WARRANTY CONCERNING CARDIAC SCIENCE PRODUCTS, EXCEPT TO REFER PURCHASERS TO THIS LIMITED WARRANTY.

YOUR EXCLUSIVE REMEDY WITH RESPECT TO ANY AND ALL LOSSES OR DAMAGES RESULTING FROM ANY CAUSE WHATSOEVER SHALL BE AS SPECIFIED ABOVE. CARDIAC SCIENCE SHALL IN NO EVENT BE LIABLE FOR ANY CONSEQUENTIAL OR INCIDENTAL DAMAGES OF ANY KIND, INCLUDING, BUT NOT LIMITED TO, EXEMPLARY DAMAGES, COMMERCIAL LOSS FROM ANY CAUSE, BUSINESS INTERRUPTION OF ANY NATURE, LOSS OF PROFITS OR PERSONAL INJURY, EVEN IF CARDIAC SCIENCE HAS BEEN ADVISED OF THE POSSIBILITIES OF SUCH DAMAGES, HOWEVER OCCASIONED, WHETHER BY NEGLIGENCE OR OTHERWISE.

Some states do not allow the exclusion or limitation of incidental or consequential damages, so the above limitation or exclusion may not apply to you.

What This Warranty Does Not Cover

This Limited Warranty does not cover defects or damages of any sort resulting from, but not limited to, accidents, damage while in transit to our service location, alterations, unauthorized service, unauthorized product case opening, failure to follow instructions, improper use, abuse, neglect, fire, flood, war or acts of God. Cardiac Science does not warrant your Cardiac Science product to be compatible with any particular other medical device.

This Limited Warranty is Void if...

Any Cardiac Science product is serviced or repaired by any person or entity other than Cardiac Science unless specifically authorized by Cardiac Science;

Any Cardiac Science product case is opened by unauthorized personnel or if a product is used for an unauthorized purpose;

Any Cardiac Science product is used in conjunction with incompatible parts or accessories, including but not limited to batteries. Parts and accessories are not compatible if they are not Cardiac Science products or the functional equivalent.

If The Warranty Period has Expired...

If your Cardiac Science product is not covered by our Limited Warranty, call us toll free at (800) 991-5465, or (952) 939-4181 for advice as to whether we can repair your Cardiac Science product, and for other repair information, including charges. Charges for non-warranty repairs will be assessed and are your responsibility. Upon completion of the repair, the terms and conditions of this Limited Warranty shall apply to such repair or replacement product for a period of 90 days.

This warranty gives you specific legal rights, and you may also have other rights, which vary from state to state.



CARDIAC SCIENCE

5420 Feltl Road
Minneapolis, MN 55343
(800) 991-Link
(952) 939-4181
(952) 939-4191 (FAX)

Limited Warranty Validation Card

Note: This card must be returned in order to validate your limited warranty and to insure traceability.

Prior to usage of this product, we recommend training for your personnel. Please contact the sales representative or dealer from which you purchased this product to arrange training. If you experience difficulty arranging training, please contact us.

_____	_____	
Model Number	Serial Number	
_____	_____	
Date of Purchase	Purchased From	

Company Name		

Contact Person		

Street Address		

_____	_____	_____
City	State	Zip Code

Telephone Number		

Extended warranties are available. Please contact your sales representative or dealer or Cardiac Science for the details.



NO POSTAGE
NECESSARY
IF MAILED
IN THE
UNITED STATES



BUSINESS REPLY MAIL
FIRST-CLASS MAIL PERMIT NO. 2135 HOPKINS, MN

POSTAGE WILL BE PAID BY ADDRESSEE

Cardiac Science, Inc.
5420 Feltl Road
Minneapolis, MN 55343-9884

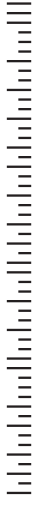

Survivalink AED Operation and Service Manual

CAUTION

Survivalink AED is intended for use by or on the order of a Physician or persons licensed by State law.

IMPORTANT

Read this Operation and Service Manual carefully. It contains information about your safety and the safety of others. Become familiar with the controls and their proper use *before* operating the product.

The Survivalink AED Models 9100/9110/9200/9210 are manufactured by:

Manufacturer:

Survivalink Corporation (wholly owned subsidiary of Cardiac Science, Inc.)
5420 Feltl Road
Minneapolis, MN 55343-7982

Authorized European Representative:

Cardiac Science International
Kirke Vaerloesevej 14
3500 Vaerloese Denmark

Trademark Information

Survivalink, *MDLink*, *SmartGauge*, *STAR*, *IntelliSense*, *RescueReady*, and *RescueLink* are trademarks and registered trademarks of Cardiac Science, Inc. *Microsoft* and *Windows* are registered trademarks of Microsoft Corporation. *COMPACTFLASH* is a trademark of SanDisk Corporation.

Limited Warranty

The Survivalink AED Operation and Service Manual and any and all information contained herein does not constitute any warranty as to the Survivalink AED or any related products in any manner whatsoever. The "Limited Warranty" is shipped with the Survivalink AED products and serves as the sole and exclusive warranty provided by Cardiac Science regarding the Survivalink AED.

Customer Service

For Customer Service, call:

(800) 991-5465
(952) 939-4181
(952) 939-4191 (fax)

Technical Support

For 24-hour service, contact Technical Support at:

(888) 466-8686 (USA only)
(952) 939-4181 (USA and Canada)
(952) 939-4191 (fax)
+45 44 38 05 39 (International)

There is no charge to the customer for a Technical Support call. Please have the serial and model numbers available when contacting Technical Support. (*The serial and model numbers are located on the bottom of the Survivalink AED.*)

Notice of Rights

All rights reserved. No part of this documentation may be reproduced or transmitted in any form by any means without the express written permission of Cardiac Science, Inc. Information in this documentation is subject to change without notice. Names and data used in the examples are fictitious unless otherwise noted.

Defibrillator Tracking

Defibrillator manufacturers and distributors are required, under the Safe Medical Devices Act of 1990, to track the location of defibrillators they sell. Please notify Survivalink Technical Support in the event that your defibrillator is sold, donated, lost, stolen, exported, destroyed or if it was not purchased directly from Cardiac Science, Inc.

Table of Contents

Section 1	Safety	7
	Safety Alert Definitions	8
	Before Operating the Survivalink AED	8
	Safety Terms and Definitions	8
	Safety Alert Descriptions	9
	Symbols Descriptions	12
Section 2	Introduction	17
	Survivalink AED	18
	Survivalink AED Description	18
	Survivalink AED Rescue Sequence	18
	Survivalink AED Parts and Features	20
	IntelliSense Battery	20
	Electrodes	20
	RescueReady Diagnostics (Self-Tests)	20
	Maintenance Indicators	20
	Rescue Data Management	20
	Text Display (Optional)	20
	Internal Clock	21
	Survivalink AED Operators and Indications for Use	22
	Who Can Use the Survivalink AED?	22
	What is the Operator's Responsibility?	22
	What are the Indications for Use?	22
	What are the Contraindications for Use?	22
	Survivalink AED Operator Training Requirements	23
Section 3	Setup	25
	Unpacking and Inspecting	26
	Survivalink AED	27
	Survivalink AED Operating and Standby Conditions	28
	Survivalink AED Shipping and Transport Conditions	28
	What You Should Know About the Batteries	29
	Lithium Battery	29
	Battery Life	30
	Battery Shelf-Life	30
	To Install the Battery	31

Table of Contents

	Activating the Survivalink AED Self-Tests	31
	What You Should Know About the Electrodes	32
	To Install the Electrodes	32
	Survivalink AED Indicators	34
	Status Indicator	34
	Audible Maintenance Indicator	34
	Diagnostic Panel	34
	SmartGauge Battery Status Indicator	35
	Electrodes Indicator	35
	Service Indicator	35
	Rescue/Resume Button	35
	Rescue Indicator	36
	Resume Indicator	36
	Text Display (Optional)	36
Section 4	Rescue -----	37
	Voice Prompt and Text Display Descriptions	38
	Pre-Rescue Safety Information	42
	Performing the Rescue	43
	Place Electrodes	43
	Survivalink AED Analyzes Rhythm	44
	Analyze/Charge/Defibrillation Shock	45
	CPR Mode	46
	Repeat Analyze/Charge/Defibrillation Shock Sequence	46
	Non-Shockable Rhythm or Patient Converts to NSR	46
	Transfer Patient to ALS Personnel	47
	Post Rescue Process	48
Section 5	Data Management -----	49
	Internal and External Data Storage Capacity	50
	Survivalink AED Internal Storage Capacity	50
	External Memory Storage	50
	Storing and Retrieving Rescue Data	51
	Inserting a Rescue Data Card Into the Survivalink AED	51
	Storing Data on a Rescue Data Card	51
	Transferring Data to a Rescue Data Card	52

Table of Contents

	Retrieving Data From a Rescue Data Card	52
Section 6	Maintenance & Troubleshooting -----	53
	Self-Tests	54
	Daily Self-Test	55
	Weekly Self-Test	55
	Monthly Self-Tests	55
	Maintenance	56
	Daily	56
	Performing the Annual Maintenance	56
	Repair Service and Service Indications	58
	Authorized Repair Service	58
	Service Indications	58
	Indicator Troubleshooting Table	59
	Rescue Questions and Answers	60
	Diagnostics Questions and Answers	62
	Battery Questions and Answers	65
Section 7	Technical Data -----	67
	Parameters	68
	Safety and Performance Standards	72
	Survivalink AED Models 9100/9110 & 9200/9210	72
	Clinical Study Summary	81
	Comparison of Survivalink's Biphasic and Monophasic Truncated Exponential Waveforms	81
	Clinical Study Conclusion	82
Section 8	Parts & Software -----	83
	Standard Parts and Software	84
	Model 9140 Standard 2-Year IntelliSense Battery	84
	Defibrillation Electrodes	84
	RescueLink Software Program	84
	Serial Communication Cable	84
	RescueLink User Manual	84
	Optional Parts and Software	85
	Model 9141 5-Year IntelliSense Extended Life Battery	85
	PCMCIA Card Adapter	85

Table of Contents

Rescue Data Storage Card	85
MDLink Options Card	85
MDLink	85
MDLink Manual	85

AED OUTLET

Safety

Overview

This section presents safety information to guard against injury to persons, and damage to the Survivalink AED. The discussions are Dangers, Cautions, Warnings, and Symbols.

Topic	Page
Safety Alert Definitions	8
Safety Alert Descriptions	9
Symbols Descriptions	12

Safety Alert Definitions

Before Operating the Survivalink AED:

Before operating the Survivalink AED, become familiar with the various safety alerts in this section.

Safety alerts identify potential hazards using symbols and words to explain what could potentially harm you, the patient or the Survivalink AED.

Safety Terms and Definitions

The triangle attention symbol shown below, left, identifies the potential hazard categories. The definition of each category is as follows:



DANGER: This alert identifies hazards that will cause serious personal injury or death.



WARNING: This alert identifies hazards that **may** cause serious personal injury or death.



CAUTION: This alert identifies hazards that **may** cause minor personal injury, product damage, or property damage.



The term "Survivalink AED" refers to Models 9100/9110 & 9200/9210.

Safety Alert Descriptions

The following is a list of Survivalink AED safety alerts that appear in this section and throughout this manual. You must read, understand, and heed these safety alerts before attempting to operate the Survivalink AED.



DANGER: Fire and Explosion Hazard

Exercise caution when operating the Survivalink AED close to flammable gases (including concentrated oxygen) to avoid possible explosion or fire hazard.



WARNING: Shock Hazard

Defibrillation shock current flowing through unwanted pathways is potentially a serious electrical shock hazard. To avoid this hazard during defibrillation abide by all of the following:

- Do not touch the patient, unless performance of CPR is indicated
- Do not touch metal objects in contact with the patient
- Keep defibrillation electrodes clear of other electrodes or metal parts in contact with the patient
- Disconnect all non-defibrillator proof equipment from the patient before defibrillation



WARNING: Shock and Possible Equipment Damage

Disconnect all non-defibrillator proof equipment from the patient before defibrillation to prevent electrical shock and potential damage to the equipment.



WARNING: Battery is Not Rechargeable

Do not attempt to recharge the battery. Any attempt to recharge the battery may result in an explosion or fire hazard.



CAUTION: Possible Radio Frequency (RF) Susceptibility

RF susceptibility from cellular telephones, CB radios, and FM 2-way radio may cause incorrect rhythm recognition and subsequent shock advisory.

When attempting a rescue using the Survivalink AED, do not operate wireless radiotelephones within 1 meter of the Survivalink AED—turn power OFF to the radiotelephone and other like equipment near the incident.



CAUTION: Moving the Patient During a Rescue

During a rescue attempt, excessive jostling or moving of the patient may cause AEDs to improperly analyze the patient's cardiac rhythm. Stop all motion or vibration before attempting the rescue.



CAUTION: Use only Survivalink Approved Equipment

Using batteries, electrodes, cables, or optional equipment other than those approved by Survivalink may cause the Survivalink AED to function improperly during a rescue.



CAUTION: Serial Communications Cable

The Survivalink AED will not perform a rescue when a serial communication cable is connected to its serial connector. The voice prompt will say, "remove cable to continue rescue."



CAUTION: Possible Interference With Implanted Pacemaker

The Survivalink AED may not advise a defibrillation shock when the patient has an implanted pacemaker.¹ However, a defibrillation attempt should be made if the patient:

- Is unconscious and
- Is not breathing and
- Has no pulse

Placing Electrodes:

- Do not place the electrodes directly over an implanted device
- Place the electrode pad at least one inch from any implanted device



CAUTION: Lithium Sulfur Dioxide Battery

Pressurized contents; never recharge, short circuit, puncture, deform, or expose to temperatures above 65°C (149°F). Remove the battery when discharged.



CAUTION: Battery Disposal

Recycle or dispose of the lithium battery in accordance with all federal, state and local laws. To avoid fire and explosion hazard, do not burn or incinerate the battery.

1. Cummins, R., ed., Advanced Cardiac Life Support; AHA (1994): Ch. 4.



CAUTION: Temperature/Humidity/Pressure Extremes

Exposing the Survivalink AED with the battery installed to extremes, outside the following operation and standby conditions, will cause the self-tests to be disabled and could cause the Survivalink AED to function improperly. Storing the Survivalink AED outside the stated temperature conditions for 5 consecutive days will result in a “*Service required*” alert.

- Temperature 0°C to 50°C (32°F to 122°F)
- Humidity 5% to 95% (non-condensing)
- Pressure 57kPa (+15,000 ft) to 170kPa (-15,000 ft)

AED OUTLET

Symbols Descriptions

The following symbols may appear in this manual, on the Survivalink AED, or on its optional components. Some of the symbols represent standards and compliances associated with the Survivalink AED and its use.



Dangerous Voltage: The defibrillator output has high voltage and can present a shock hazard. Please read and understand all safety alerts in this manual before attempting to operate the Survivalink AED.



Attention!: Identifies important information in this manual, on the Survivalink AED, or on its component parts regarding the safe and proper use of the Survivalink AED.



Defibrillator Proof Type BF Equipment: The Survivalink AED, when connected to the patient's chest by the electrodes, can withstand the effects of an externally applied defibrillation shock without diverting the shock from the patient or into the Survivalink AED.



CE Mark: This equipment conforms to essential requirements of the Medical Device Directive 93/42/EEC.

IP23

The Survivalink AED is protected against the effects of spraying water in accordance with IEC 529.



Classified by Underwriters Laboratories Inc. with respect to electric shock, fire and mechanical hazards only in accordance with UL 2601-1 and IEC 601-2-4, IEC SC 62D/WG2 (O'Dowd) and CAN/CSA C22.2 No.601.1-M90.



International symbol for ON. Open the lid to turn ON the Survivalink AED.

TSO-C97

FAA TSO marking: This battery conforms to the FAA lithium sulfur dioxide batteries technical standard order, TSO C97.

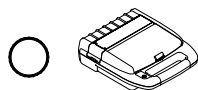

International symbol for OFF. Close the lid to turn OFF the Survivalink AED.

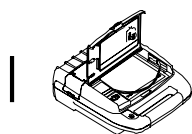

Open the lid to turn ON the Survivalink AED.

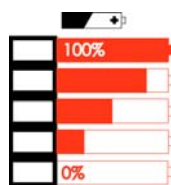

Indicates the Survivalink AED battery status. The shaded areas indicate the remaining battery capacity.



Check the electrodes. The electrodes are either missing or out of specification. Also, on the electrode packaging, this symbol represents one pair.



Indicates Survivalink AED requires maintenance by authorized service personnel.

RESCUE



When lit, push this button to deliver a defibrillation shock.



RESUME

When lit: push this button to clear the internal memory to allow storage of new rescue data in the Survivalink AED.



RED with a BLACK X means the Survivalink AED requires operator attention or maintenance, and is not RescueReady. For purposes of retaining simple, clear instructions, this symbol will be referred to as RED in the remainder of this manual.



GREEN without a BLACK X means the Survivalink AED is RescueReady. For purposes of retaining simple, clear instructions, this symbol will be referred to as GREEN in the remainder of this manual.



Use by or install by date.

Exp. Date

Expiration Date. Replace by this date.



Latex Free.



Disposable. Single patient use only.



Tear here to open.



Do not recharge battery.



The patient is unconscious.



The patient is not breathing.



The patient has no pulse.

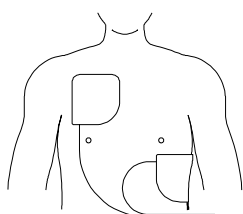

Place the electrodes on the chest of the patient.



The maximum energy delivered.



For use by or on the order of a Physician, or persons licensed by state law.



Dispose of properly in accordance with all state, province, and country regulations.



Do not incinerate or expose to open flame.



Explosion Hazard: Do not use in the presence of a flammable gas, including concentrated oxygen.

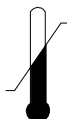

Upper and lower temperature limits.

SN

Serial Number.

Lot

Lot Number.



Additional information is provided in the Survivalink AED Operation and Service Manual.



Points to important information regarding the use of the Survivalink AED.



Lift Here

AED OUTLET

Introduction

Overview

This section presents information about the Survivalink AED, its use, and the training requirements for operation.

Topic	Page
Survivalink AED	18
Survivalink AED Parts and Features	20
Survivalink AED Operators and Indications for Use	22
Survivalink AED Operator Training Requirements	23

Survivalink AED

Survivalink AED Description

The Survivalink AED is a self-testing battery-operated automated external defibrillator (AED). After applying the Survivalink AED's electrodes to the patient's chest, the Survivalink AED automatically analyzes the patient's Electrocardiogram (ECG). The Survivalink AED advises you to deliver a defibrillation shock upon analyzing one of the following shockable-cardiac rhythms:

- Ventricular fibrillation - when peak to peak amplitude is greater than asystole threshold (0.15 mV nominal) and the cardiac rhythm rate is at least 180 bpm (Beats Per Minute)
- Ventricular tachycardia - cardiac rhythm rate is at least 180 bpm
- Supraventricular tachycardia¹ - cardiac rhythm rate is at least 180 bpm

The Survivalink AED uses one button for all operations. It also guides you through the rescue using a combination of voice prompts, audible alerts, and visible indicators.

Survivalink AED Rescue Sequence

The Survivalink AED rescue sequence is consistent with the guidelines recommended by the American Heart Association (AHA)² and the European CPR Guidelines or Universal ALS (European Precool).

Upon detecting a shockable cardiac rhythm, the Survivalink AED advises you to press the "Rescue" button to deliver a series of up to three (3) defibrillation shocks followed by performing one minute of CPR.

The Survivalink AED will prompt for one (1) minute of CPR, per AHA Guidelines.

Note: The "European CPR Protocol" can be enabled using Cardiac Science's MDLink software. All units shipped to European countries that follow the European Resuscitation Council's guidelines will have this option enabled at the factory.

When enabled, three (3) minutes of CPR will be administered if the first analysis decision is non-shockable or following two consecutive non-shockable analysis decisions.

1. "Guidelines for Cardiopulmonary Resuscitation and Emergency Care," *Journal of the American Medical Association* (Oct. 28, 1992), Vol. 268, No. 16: 2211-2212.
2. Defibrillation. In: Cummins R, ed. *Advanced Cardiac Life Support*: American Heart Association; 1997:4-9.



The European CPR Guidelines or Universal ALS (European Protocol) recommends up to 3 minutes of CPR if the first analysis decision is non-shockable or following two consecutive non-shockable analysis decisions.

The three (3) defibrillation shocks are delivered in a pre-programmed sequence of escalating monophasic, or biphasic energies.

The Survivalink AED Models 9100/9110 first defibrillation shock is set at 200J. The second defibrillation shock is programmable for either 200J or 300J. The third defibrillation shock and all subsequent shocks are set at the maximum energy which is 360J.

The Survivalink AED Models 9200/9210 first defibrillation shock is set at a low current³ setting. The second defibrillation shock is programmable for either low current or high current. The third defibrillation shock and all subsequent shocks are set at the high current setting.

AED OUTLET

3. FirstSave Models 9200/9210: The low current and high current shocks are variable energy. The actual energy is determined by the patient's impedance.

Survivalink AED Parts and Features

IntelliSense Battery

The *IntelliSense* battery is a non-rechargeable battery, incorporating an integrated memory chip that maintains the complete battery history.

IntelliSense battery technology allows the Survivalink AED to determine battery capacity, even if the battery is moved from one Survivalink AED unit to another.

Electrodes

Proper electrode placement instructions appear on the electrodes and the electrode packaging.

Use the electrodes for one rescue only.

RescueReady Diagnostics (Self-Tests)

The Survivalink AED automatically performs a comprehensive self-test of these internal parts:

- Electronics
- Battery
- Electrodes
- High voltage circuitry

Maintenance Indicators

When the Survivalink AED requires maintenance, audible and/or visible indicators will become active. By monitoring these indicators you can be sure the Survivalink AED is ready to perform a rescue.

Rescue Data Management

You can store rescue data in the internal memory of the Survivalink AED, or externally on an optional Rescue Data Card with the Survivalink AED Models 9110 or 9210.

Using Cardiac Science's *RescueLink* software program on your personal computer (PC), you can download the rescue data from the Survivalink AED's internal memory, or from the Rescue Data Card to your PC. You can then view, store, or print the data.

Text Display (Optional)

Survivalink AED Models 9200 and 9210 can be equipped with a text display. During a rescue, the text display provides the rescuer with the voice prompts in written form, elapsed time of rescue and number of

shocks delivered. The text screen also provides instruction during service mode.

Internal Clock

Survivalink AED's internal clock is used to record the time of all significant rescue events. The internal clock is set using the RescueLink software program.

The internal clock will automatically adjust itself for daylight savings time, leap years, etc. The daylight savings time feature can be disabled with MDLink.

AED OUTLET

Survivalink AED Operators and Indications for Use

Who Can Use the Survivalink AED?

After meeting the Survivalink AED training requirements, the following persons qualify to operate the Survivalink AED:

- Physicians or persons authorized by state, province, or country regulations in which they practice
- Persons trained in basic life support, advanced cardiac life support, or emergency medical response while under the direction of a Physician

What is the Operator's Responsibility?

The operator is responsible for the safe and effective use of the Survivalink AED and its accessories. This involves:

- Following the safety alerts and operating procedures in this manual
- Following maintenance schedules and operating procedures for the Survivalink AED and its accessories
- Obtaining training in the use of the Survivalink AED and its accessories

What are the Indications for Use?

Use the Survivalink AED only for emergency treatment of sudden cardiac arrest, if the patient:

- Is unconscious
- Is not breathing
- Has no pulse

What are the Contraindications for Use?

Do not use the Survivalink AED for emergency treatment if the patient:

- Is conscious; or
- Is breathing; or
- Has a pulse; or
- Is under eight years of age⁴

4. American Heart Association, "Advance Cardiac Life Support" edited by R.O Cummins, page 4-11, 1994.

Survivalink AED Operator Training Requirements

Persons authorized to operate the Survivalink AED must have all of the following minimum training and experience:

- CPR certification
- Defibrillation training and other training as required by state, province, or country regulations
- Survivalink AED training before use in an actual rescue
- Additional training as required by the Medical Director
- A thorough understanding of the procedures in this manual



Keep certificates of training and certification as required by state, province, or country regulations.

AED OUTLET

Setup

Overview

This section presents information on unpacking and setting up the Survivalink AED.

Topic	Page
Unpacking and Inspecting	26
Survivalink AED	27
What You Should Know About the Batteries	29
What You Should Know About the Electrodes	32
Survivalink AED Indicators	34

Unpacking and Inspecting

Every attempt is made to ensure your order is accurate and complete. However, to be sure that your order is correct, verify the contents of the box against your packing slip.



If you have any question about your order, contact Cardiac Science Customer Service Department at: (800) 991-5465 or (952) 939-4181, or your local Cardiac Science distributor.

AED OUTLET

Survivalink AED

The following drawings show the Survivalink AED parts and their locations.

- A = Lid
- B = Latch (push in & up to open)
- C = Status indicator
- D = Data access door
- E = Battery compartment

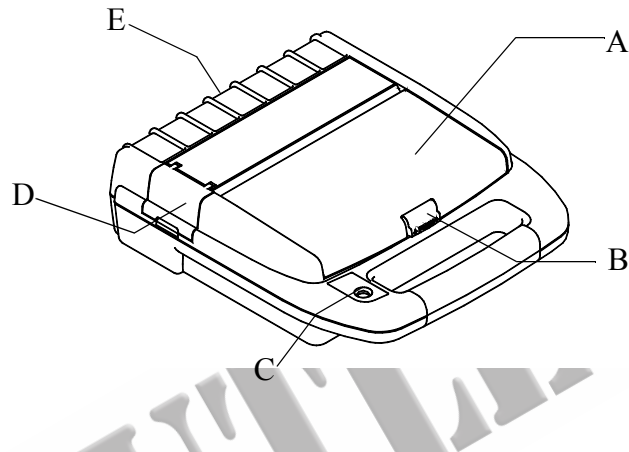

- F = Speaker
- G = Electrode connector
- H = Diagnostic panel
- I = Card Slot (models 9110/9210)
- J = Serial communication port
- K = Spare flash card storage
- L = Text display
(available on models 9200D/
9210D)

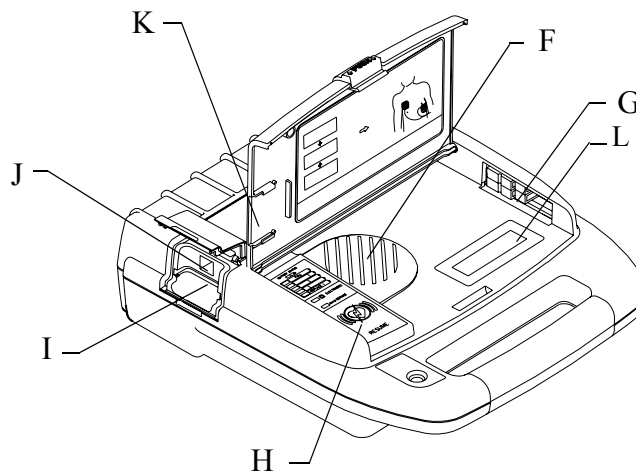

The term “Survivalink AED” refers to Models 9100/9110 and 9200/9210.

The Survivalink AED will operate within a specified condition. This range varies depending on whether the device is in Operating, Standby, or Storage Mode.

Operating Mode - is defined as having the battery installed and the lid open. This is the mode it would be in during an actual rescue situation.

Standby Mode - is when the battery is installed, but the lid is closed. This is the normal mode for the Survivalink AED to be in between rescues. In this mode, the device will conduct its routine self-tests to determine that it is operating correctly.

Storage Mode - is when the battery is removed, such as during shipping or transport. With the battery removed, the Survivalink AED is unable to perform self-tests or rescues.

Survivalink AED Operating and Standby Conditions

Temperature	0°C to 50°C (32°F to 122°F)
Humidity	5% to 95% (non-condensing)
Atmospheric Pressure	57kPa to 170kPa



CAUTION: Temperature/Humidity/Pressure Extremes

Exposing the Survivalink AED with the battery installed to extremes, outside the operation and standby conditions, will cause the self-tests to be disabled and could cause the Survivalink AED to function improperly. Storing the Survivalink AED outside these conditions for 5 consecutive days will result in a “service required” alert.

Survivalink AED Shipping and Transport Conditions

(for up to 1 week)

Temperature	-40°C to 65°C (-40°F to 149°F)
Temperature W/Display	-30°C to 65°C (-22°F to 149°F)
Humidity	5% to 95% (non-condensing)
Atmospheric Pressure	57kPa to 170kPa

What You Should Know About the Batteries



CAUTION: Lithium Sulfur Dioxide Battery

Pressurized contents; never recharge, short circuit, puncture, deform, or expose to temperatures above 65°C (149°F). Remove the battery when discharged.

Lithium Battery

A = +12V
B = +5V
C = DATA
D = GND (-)

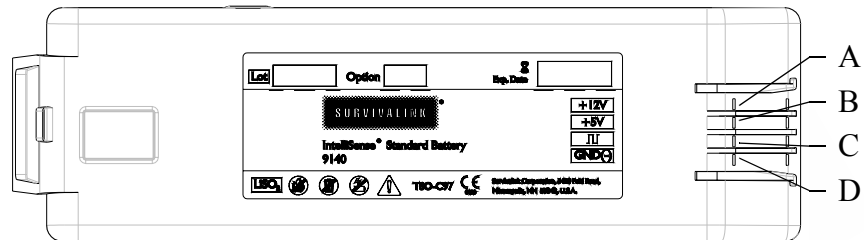

The unique Cardiac Science IntelliSense battery technology means that you will never be surprised during a rescue because of a depleted or dead battery. Our IntelliSense batteries contain an integrated memory chip that automatically stores important usage information, enabling the battery to maintain a complete history of its operation life. This history includes:

- Battery Identification
- Battery Type
- Original Date of Installation
- Number of Charges Completed
- Time in Operation (hours:minutes)
- Days of Standby Operation
- Battery Capacity Remaining

The IntelliSense battery technology offers you the most advanced battery capabilities available for defibrillators. Future battery technologies may be incorporated by simply modifying the programming in the integrated memory chip. This means that as battery technologies evolve, Cardiac Science will be able to offer you the most current innovations.

Battery Life

The expected life of a Cardiac Science battery is defined as the number of years the battery can be expected to last when installed in the Survivalink AED. The following table represents the expected life of the Survivalink AED when used in Standby Mode.

Model	Expected Operating Life
9141 Extended Life Lithium	5 years

The expected life will decrease as the Survivalink AED is used in Operating Mode.

Store the Survivalink AED with the battery installed at temperatures between 0°C to 50°C (32°F to 122°F) and relative humidity between 5% to 95% (non-condensing).

Note: Storing the Survivalink AED with the battery installed at extreme temperatures may decrease battery life.

Battery Shelf-Life

All Cardiac Science batteries have a shelf-life of five years. Shelf-life is defined as the length of time a battery can be stored, prior to installation into the Survivalink AED, without degrading its performance.

Store batteries, not installed in the Survivalink AED, at temperatures between 0°C to 50°C (32°F to 122°F) and relative humidity between 5% to 95% (non-condensing).



WARNING: Battery is Not Rechargeable

Do not attempt to recharge the battery. Any attempt to recharge the battery may result in an explosion or fire hazard.



CAUTION: Battery Disposal

Recycle or dispose of the lithium battery in accordance with all federal, state, and local laws. To avoid fire and explosion hazards, do not burn or incinerate the battery.



CAUTION: Possible Improper Device Performance

Use of any batteries other than those approved by Cardiac Science may cause the Survivalink AED to function improperly during a rescue. The use of other brands of batteries other than those approved by Cardiac Science may void the Cardiac Science Limited Warranty.



If a depleted battery is not able to be disposed of properly, label the battery in some manner to prevent it from being reused.

To Install the Battery

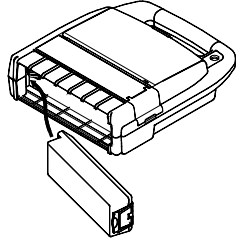

1. With the label on the battery facing the Survivalink AED battery compartment, insert the battery as shown in the drawing.

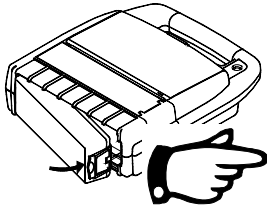

2. Push the latched end of the battery firmly into the Survivalink AED, as shown in the drawing, until the battery snaps into place—you will hear a loud click. The exposed side of the battery should be flush with the outside of the Survivalink AED case.

If the battery is not properly installed, the Survivalink AED will not operate.

Activating the Survivalink AED Self-Tests

The “Status” indicator on the Survivalink AED handle will only turn GREEN (RescueReady) after the self-test is complete. To activate a self-test:

1. Open the lid of the Survivalink AED and the following should occur:
 - The indicator lights on the diagnostic panel will toggle sequentially On/Off while the Survivalink AED performs its daily self-tests
 - After the Survivalink AED completes the tests, you will hear the voice prompt, “Place Electrodes” - The status indicator on the Survivalink AED handle will switch to GREEN
2. Close the lid—the Survivalink AED is RescueReady.



What You Should Know About the Electrodes

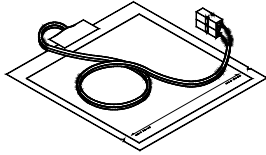

The electrodes come in a ready-to-use sealed package, containing one pair of self-adhesive electrodes with an attached cable and connector. The electrodes are disposable and should be thrown away after one rescue.

The electrodes have a limited shelf-life and should not be used beyond the expiration date. Keep a fresh pair of electrodes plugged into the Survivalink AED at all times.

Refer to the operating instructions on the electrode package for operation temperatures.

Note: Storing the Survivalink AED with the electrodes installed at extreme temperatures may decrease electrode shelf-life.



An audible alert will be heard after the daily self-test if the electrodes are missing, damaged, or unplugged. The audible alert will not be heard if the Electrode Test selectable option is disabled using MDLink.



CAUTION: Use Only Cardiac Science Approved Equipment

Using *batteries, electrodes, cables, or optional equipment* other than those approved by Cardiac Science may cause the Survivalink AED to function improperly during a rescue.



CAUTION: Possible Improper AED Performance

Using electrodes that are damaged or expired may result in improper AED performance. Examine the electrodes before use. The electrode package seal should be intact and the electrode expiration date should not be expired.



Do not open or remove the outer wrapper of the electrode package until performing a rescue. If the wrapper is opened or damaged, do not use the electrodes.

To Install the Electrodes

1. Remove one of the expiration-date stickers from the surface of the electrode package and apply it to the outside of the Survivalink AED. The expiration date of the electrodes will then be readable without opening the lid of the Survivalink AED.
2. Open the lid of the Survivalink AED.

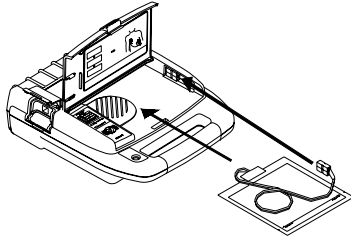

3. Match the color code of the connectors (red to red), then slide the electrode connector along the recess in the Survivalink AED case as shown in the drawing, until the electrode connector fully mates to the connector of the Survivalink AED.

4. Slide the electrode package fully into the Survivalink AED electrode compartment, inserting the cable end first, as shown in the drawing.

5. Loop the excess cable length as shown in the drawing.

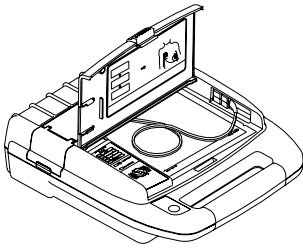

6. With the electrode package completely under the Survivalink AED lid, as shown in the drawing, close the lid.

AED OUTLET

Survivalink AED Indicators

The following indicators are located on the Survivalink AED.

Status Indicator

The status indicator is located on the Survivalink AED handle. When this indicator turns GREEN, the Survivalink AED is RescueReady. This means the Survivalink AED self-tests have verified the following:

- Battery has an adequate charge
- Electrodes are properly connected
- Integrity of the internal circuitry is good

When the “Status indicator” is RED, maintenance is required.

Audible Maintenance Indicator

When the daily or monthly self-tests determine maintenance is required, an audible warble beep is sounded every 30 seconds, until the lid is opened, the battery is removed, or the battery power is depleted. For maintenance not requiring qualified service personnel, closing the lid will deactivate the audible warble beep until the next self-test determines the need for maintenance.

Refer to the Maintenance & Troubleshooting section when maintenance is required.

Diagnostic Panel

The diagnostic panel is under the lid of the Survivalink AED and contains various indicators and a button:

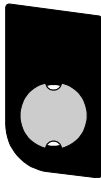

A = SmartGauge Battery Status Indicator

B = Electrodes Indicator

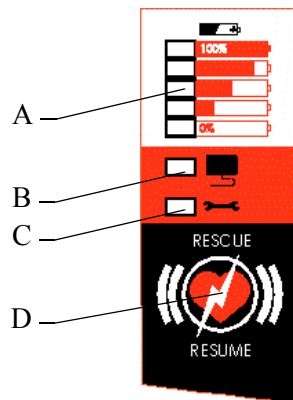

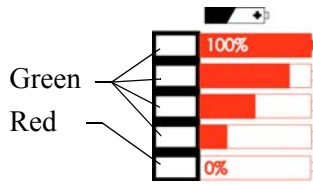

SmartGauge Battery Status Indicator

The SmartGauge “Battery Status” indicator has five (5) LEDs, four (4) GREEN and one (1) RED. The top four GREEN LEDs display the remaining capacity of the battery much like a fuel gauge. With use, the GREEN LEDs gradually go out, from top to bottom, as battery capacity decreases. When the green LEDs go completely out and the bottom RED LED lights, replace the battery.



When the bottom Red LED initially lights, upon opening the lid or at any time during a rescue, you will hear the “Battery Low” prompt once. However, the Survivalink AED should still be capable of delivering approximately 9 more defibrillation shocks.

When the Survivalink AED battery cannot deliver any more shocks, it continuously repeats the “Battery low” prompt. To continue the rescue, leave the lid “Open” and replace the battery. You have 60 seconds to install the battery. If 60 seconds expire or the lid is closed for more than 15 seconds during battery installation, the rescue sequence starts over.

If the battery is completely depleted of power, all Survivalink AED electrical activity will terminate.



Electrodes Indicator

The “Electrodes” LED lights up when the electrodes are:

- Disconnected from the patient
- Not properly connected to the Survivalink AED
- Not within specifications (cold, dirty, damaged)



Service Indicator

The “Service” LED lights up when the Survivalink AED requires maintenance that can only be performed by qualified service personnel.

Rescue/Resume Button

The Survivalink AED has one button called the “Rescue/Resume” button; it is used for all operations. This button is located on the diagnostic panel and serves two functions:

- Delivers a defibrillation shock (Rescue)
- Clears the internal memory of previous rescue data so that new rescue data can be stored (Resume)



Rescue Button
Indicator LEDs



Resume Button
Indicator LEDs

Text Identifier

Voice Identifier

Internal Code
Identifier

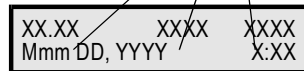

Current Date

Current Time

Elapsed Rescue
Time

Number of Shocks
Delivered



Voice Prompt or
Message

Rescue Indicator

The word “Rescue” and the rescue button indicator LEDs will illuminate RED when the Survivalink AED is ready to deliver a defibrillation shock to the patient.

Resume Indicator

The word “Resume” will illuminate YELLOW and the resume button indicator LEDs will illuminate RED when one of the following conditions occurs:

- Internal and external memory are already full at the start of a rescue
- Electrodes are placed on the patient before opening the lid

Text Display (Optional)

The text display is a backlit Liquid Crystal Display (LCD) with 2 lines of text, each having 20 characters. The text display provides the rescuer with information regarding system initialization, text prompts and data during a rescue, and diagnostics.

System initialization occurs when the lid is first opened. The text display shows the user the identifiers for the internal code, voice prompts and text prompts versions. The text display also shows the current date and time.

During a rescue, the text display shows the number of shocks delivered and the elapsed time from the beginning of the rescue (when the lid was first opened). The text version of the voice prompts will also be displayed.

The text display will also display information useful in assessing the status of the AED and other informational messages.

Each voice prompt or message may be associated with one or two lines of text; If two lines of text are used, the text will alternate every 1-1/2 seconds.

Note: There is a 3 second delay between the time the AED lid is opened and the start of the rescue. This 3 seconds is not included in the elapsed rescue time.

Section 4 Rescue

Overview

This section presents information about how to use the Survivalink AED to perform a rescue.

Topic	Page
Voice Prompt and Text Display Descriptions	38
Pre-Rescue Safety Information	42
Performing the Rescue	43
Post Rescue Process	48

Voice Prompt and Text Display Descriptions

The voice prompts are announced when you open the Survivalink AED lid and at appropriate times during a rescue. On Survivalink AED Models equipped with the text display the text displayed mimics most of the audible voice prompts. Also displayed is system initialization, rescue, and diagnostics information.

In some cases the text displayed is an abbreviated version of the actual voice prompts. The following table lists the voice and text prompts and their respective meanings.

Voice Prompt	Optional Text Display 9200/9210 Models only	When You Will Hear the Prompt
Place electrodes	PLACE ELECTRODES	When you open the lid of the Survivalink AED, the phrase repeats every 5 seconds until you place the electrodes on the patient or you close the lid.
Do not touch patient! Analyzing rhythm	DO NOT TOUCH PATIENT ANALYZING RHYTHM	Repeatedly while the Survivalink AED analyzes the cardiac rhythm of the patient after the electrodes have been placed and again after CPR has been performed.
Charging	CHARGING	When the Survivalink AED is preparing to deliver a defibrillation shock.
Stand clear! Push flashing button to rescue	STAND CLEAR PUSH BUTTON TO SHOCK	After the Survivalink AED is fully charged and ready to deliver the defibrillator shock. "Stand Clear" means that no one should be touching the patient. The RED "Rescue" indicator flashes and the phrase repeats for 30 seconds or until you push the "Rescue" button.

Voice Prompt	Optional Text Display 9200/9210 Models only	When You Will Hear the Prompt
Check pulse! If no pulse, give CPR	CHECK PULSE IF NO PULSE GIVE CPR	One of the following: <ul style="list-style-type: none"> • After the Survivalink AED delivers 3 consecutive defibrillation shocks and suspends analyzing for one minute • After the Survivalink AED detects a non-shockable cardiac rhythm during cardiac rhythm analysis • When the Survivalink AED detects a shockable cardiac rhythm, but the “Rescue” button is not pushed for approximately 2 1/2 minutes from the placement of electrodes on the patient or performing CPR
Check electrodes	CHECK ELECTRODES	During the rescue, if the electrodes become detached from the patient or the Survivalink AED, so the Survivalink AED cannot detect the cardiac rhythm. The rescue will continue after you correct the electrode placement problem.
Battery low	BATTERY LOW	Occurs once when the battery voltage becomes low, although a rescue can continue for approximately 9 more shocks. When the battery is too low to do a rescue, the phrase repeats continuously and you must replace the battery before continuing with the rescue. If completely depleted, all Survivalink AED activity will terminate.

Voice Prompt	Optional Text Display 9200/9210 Models only	When You Will Hear the Prompt
Data in memory! Do not push “Resume” button until data is down- loaded, unless you must do a rescue	DATA IN MEMORY PUSH BUTTON TO CLEAR	When all available memory sources are full. The YELLOW “Resume” indicator flashes and the phrase repeats until you download the data and clear memory, press the “Rescue/Resume” button, or insert an empty Rescue Data Card.
Card full! Storing internally	CARD FULL STORING INTER- NALLY	When the optional Rescue Data Card, installed in the Survivalink AED Model 9110 or 9210, is full. The rescue data will be stored in the internal memory of the Survivalink AED.
Remove cable to continue rescue	REMOVE CABLE	When a serial communication cable is connected to the Survivalink AED during a rescue, the phrase repeats until the cable is disconnected.
Communications Mode	COMMUNICATIONS MODE	When the lid is open with a serial communications cable plugged into the Survivalink AED.
Program Mode	PROGRAM MODE	One of the following: <ul style="list-style-type: none"> • When you install the MDLink Options Card before opening the lid, and after opening the lid you immediately hold down the “Rescue/Resume” button (see MDLink manual) • When you are downloading the rescue-event data from the internal memory of the Survivalink AED to a blank Rescue Data Card (see Data Management section)

Voice Prompt	Optional Text Display 9200/9210 Models only	When You Will Hear the Prompt
Audible alerts		<p>“Two-Tone Beep” occurs after inserting an optional Rescue data card or a MDLink options card into the Survivalink AED’s card slot, with the lid open. Also occurs in 15-second intervals during CPR when enabled by the MDLink software program.</p> <p>“Warble Beep” occurs when the Survivalink AED requires maintenance.</p>
Press flashing button to continue rescue	PRESS BUTTON TO CONTINUE RESCUE	When you open the Survivalink AED lid and the electrodes are attached to the patient and connected to the Survivalink AED. The YELLOW “Resume” indicator flashes and the phrase will repeat until you press the “Rescue/Resume” button.
Continue CPR	CPR X:XX	Phrase repeats in 15-second intervals during CPR mode. You can enable the “Continue CPR” prompt using the MDLink software program.
Asystole	ASYSTOLE	Occurs when the Survivalink AED detects “Asystole” during ECG analysis. You can enable the “Asystole” prompt using the MDLink software program.
Service required	SERVICE REQUIRED	<p>Occurs when the self-tests determine that the Survivalink AED is not functioning properly.</p> <p>The RED “Service” indicator will illuminate and “Service required” will repeat until you close the lid. After closing the lid, a “warble beep” will be heard until the battery is removed or becomes completely depleted.</p>

Pre-Rescue Safety Information

The following cautions must be observed to prevent problems during the rescue.



CAUTION: Fire and Explosion Hazard

Exercise caution when operating the Survivalink AED close to flammable gases (including concentrated oxygen) to avoid possible explosion or fire hazard.



CAUTION: Possible Radio Frequency (RF) Susceptibility

RF susceptibility from cellular telephones, CB radios, and FM 2-way radio may cause incorrect rhythm recognition and a subsequent shock advisory.

When attempting a rescue using the Survivalink AED, do not operate wireless radiotelephones within one meter of the Survivalink AED—turn power OFF to the radiotelephone and other like equipment near the incident.



CAUTION: Possible Improper AED Performance

The Survivalink AED will not function during a rescue when the serial communication cable is connected to its serial port. When the serial communication cable is connected to the Survivalink AED during a rescue, the prompt will say “*Remove cable to continue rescue*” until you remove the serial communication cable from the Survivalink AED.



CAUTION: Possible Interference With Implanted Pacemaker

The Survivalink AED *may not* advise a defibrillation shock when the patient has an implanted pacemaker.¹

However, a defibrillation attempt should be made if the patient:

- Is unconscious and
- Is not breathing and
- Has no pulse

Placing Electrodes:

- Do not place the electrodes directly over an implanted device
- Place the electrode pad at least one inch from any implanted device

1. Cummins, R., ed., *Advanced Cardiac Life Support*; AHA (1994): Ch. 4.

Performing the Rescue

Assess the Patient

1. Determine that the patient is over 8 years of age and exhibits all of the following:

Unconscious



Not breathing



Has no pulse

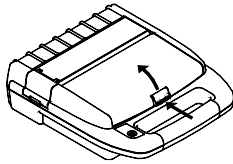
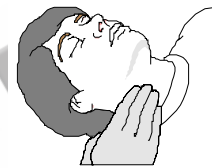

2. Turn the Survivalink AED ON by pushing the lid's release button "In" and "Up" to open the lid. The LEDs on the diagnostic panel will sequence "On" and "Off" until the self-test is completed at which time the voice prompt will say, "Place Electrodes."



If you close the lid during a rescue, you must re-open the lid within 15 seconds to continue the rescue. If the lid remains closed for more than 15 seconds, a new rescue will initiate when the lid is re-opened.

Note: During a rescue, the text display provides the rescuer with the voice prompts in written form, elapsed time of rescue and number of shocks delivered. For a complete description of displayed text, see "Voice Prompt and Text Display Descriptions" on page 38.

Place Electrodes

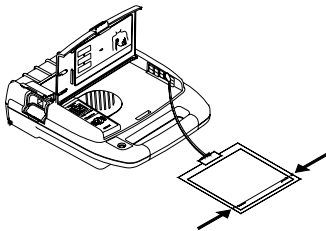

3. With the electrodes connected to the Survivalink AED as shown in the drawing, tear the outer electrode package along the dotted line, and pull the electrodes from the package. Leave the package attached to the electrode wires.
4. Before placing electrodes, remove the chest clothing of the patient exposing the bare skin. Prepare the chest of the patient as directed by the medical director and make sure the skin is as clean, dry, and oil free as practical.

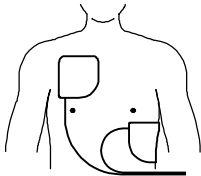
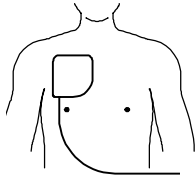
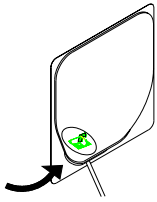

Note: The electrodes are self-adhesive and ready to apply.

5. With a firm, steady pull, carefully peel one electrode away from the release liner.
6. Place the electrode with the adhesive side on the patient's skin on the upper right chest, placing the top of the electrode on the collarbone, as shown in the drawing. Avoid placing the electrode directly over the sternum.
7. With a firm, steady pull, carefully peel the other electrode away from the release liner.
8. Place the other electrode on the lower left chest, placing the bottom on the lower margin of the rib cage.

Note: Standard defibrillation electrodes can be placed in either position as shown on the electrode package. When using pacing/monitoring electrodes, refer to the placement instructions on the pacing/monitoring electrode package.

9. When the electrodes are placed, the voice prompt will say, "Do not touch patient. Analyzing rhythm". If the electrodes become disconnected from the Survivalink AED or the patient, the voice prompt will say, "Check electrodes". Check the following:
 - a. Make sure the electrodes are firmly placed on clean dry skin.
 - b. Electrode cables are securely plugged into the Survivalink AED.



Energy can only be delivered to the electrodes after the electrodes are properly placed, the "Rescue" indicator is flashing, and the Survivalink AED is sounding a continuous charged tone.

Ensure the patient is not being moved while the Survivalink AED is analyzing because this may cause incorrect rhythm analysis.

Survivalink AED Analyzes Rhythm

As soon as the Survivalink AED detects proper electrode placement, the voice prompt will say, "Do not touch patient. Analyzing rhythm." The Survivalink AED will begin to analyze the cardiac rhythm of the patient.

- a. If the Survivalink AED detects a shockable cardiac rhythm, the voice prompt will say, “*Charging*” and the Survivalink AED prepares to deliver a defibrillation shock.
- b. If the Survivalink AED does not detect a shockable rhythm, the voice prompt will say, “*Check pulse. If no pulse, give CPR.*”

Note: If the Asystole prompt has been enabled using MDLink and the Survivalink AED detects Asystole, you will hear the “Asystole” voice prompt before the “Check pulse. If no pulse, give CPR” voice prompt. See the MDLink Manual.

When the Survivalink AED is ready to deliver a defibrillation shock, you will:



- See the word “Rescue” flashing above the button and
- Hear the charged tone and
- Hear the voice prompt say, “*Stand clear. Press flashing button to rescue*”

10. Push the “Rescue” button to deliver the first defibrillation shock.

Note: If you do not push the “Rescue” button within 30 seconds of hearing the prompt, the Survivalink AED will disarm and re-analyze the cardiac rhythm. If a shockable rhythm is still detected, the “Stand clear. Press flashing button to rescue” prompt repeats. If a shockable rhythm continues to be detected, but the “Rescue” button is not pushed for approximately 2 1/2 minutes from the placement of electrodes or performing CPR, the voice prompt will say, “Check pulse. If no pulse, give CPR.” Perform CPR if there is no pulse.

Analyze/Charge/Defibrillation Shock

After the Survivalink AED delivers the first defibrillation shock, the voice prompt will say, “*Do not touch patient. Analyzing rhythm.*” The Survivalink AED analyzes the cardiac rhythm of the patient again. If the Survivalink AED determines that a shockable cardiac rhythm still exists, it will charge, then issue another voice prompt instructing you to deliver another defibrillation shock.

11. Push the “Rescue” button to deliver the second defibrillation shock.

Note: The analyze/charge/defibrillation process will occur a maximum of three consecutive times.

12. If at any time the patient has a non-shockable cardiac rhythm, the voice prompt will say, “*Check pulse. If no pulse, give CPR.*” Perform CPR if there is no pulse.

Note: During a rescue, the text display provides the rescuer with the voice prompts in written form, elapsed time of rescue and number of shocks delivered. For a complete description of displayed text, see "Voice Prompt and Text Display Descriptions" on page 38.

CPR Mode



After the third defibrillation shock is delivered, the voice prompt will say, "Check pulse. If no pulse, give CPR."

Note: During CPR, AED's equipped with the optional text display will show a countdown CPR timer.

13. Perform CPR if the patient has no pulse.

Note: If the "Continue CPR" prompt or "two-toned beep" option has been enabled using MDLink, you will hear a "Continue CPR" voice prompt or a beep every 15 seconds during the CPR session. See the MDLink Manual.

Repeat Analyze/Charge/Defibrillation Shock Sequence

After CPR, the voice prompt will say, "Do not touch patient. Analyzing rhythm." The Survivalink AED will again, analyze the patient's cardiac rhythm; upon detecting a shockable rhythm, the three-shock sequence will repeat.

The analyze/charge/defibrillation shock sequence of three defibrillation shocks, followed by CPR will repeat until one of the following occurs:

- A non-shockable rhythm is detected
- Electrodes are disconnected
- The maximum number of defibrillation shocks per rescue is reached

Non-Shockable Rhythm or Patient Converts to NSR

If the patient has a non-shockable rhythm, or, at some point during the rescue sequence, converts to a non-shockable rhythm, the voice prompt will say, "Check pulse. If no pulse, give CPR."

- If the patient is not breathing, continue CPR
- If the patient has a pulse, is conscious and breathing normally, make the patient as comfortable as possible and wait for Advanced Life Support (ALS) to arrive
- Continue to follow the voice prompts until the ALS personnel arrive, or proceed as recommended by the Medical Director

Transfer Patient to ALS Personnel

1. With the electrodes still attached to the patient, disconnect the electrodes from the Survivalink AED.
2. Close the lid of the Survivalink AED.
3. Allow the ALS personnel to transport the patient to the hospital or proceed as recommended by the Medical Director.

AED OUTLET

Post Rescue Process

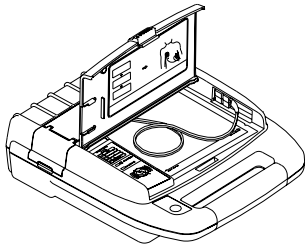
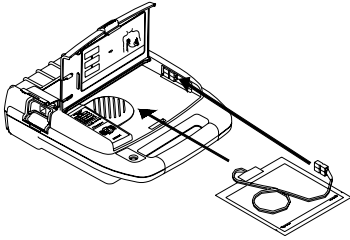

After transferring the patient to ALS personnel, do the following to prepare the Survivalink AED for the next rescue:

1. Connect a new pair of electrodes to the Survivalink AED.
2. Check the expiration date on the electrode package for expiration.
3. Place one electrode expiration date sticker on the outside of Survivalink AED where it can be viewed without opening the lid.
4. Place the new electrodes in the storage space.
5. Verify that the “Replace” indicator is not lit. If it is, replace the battery.
6. Close the lid.
7. Verify that the “Status” indicator on the Survivalink AED handle is GREEN.
8. Retrieve the rescue data stored in the internal memory of the Survivalink AED or from a Rescue Data Card by using RescueLink installed on a PC. (Complete this step before the next rescue to prevent loss of rescue data).



After retrieving the rescue data, erase the internal memory of the Survivalink AED or the Rescue Data Card before preparing for a new rescue as outlined in the RescueLink User Manual.

9. Insert a blank Rescue Data Card into the Survivalink AED card slot (Model 9110 or 9210 only).

Section 5 Data Management

Overview

This section presents information about the Survivalink AED Rescue Data Cards, internal and external storage capacities, and storing and retrieving rescue data.

Topic	Page
Internal and External Data Storage Capacity	50
Storing and Retrieving Rescue Data	51

Internal and External Data Storage Capacity

Survivalink AED Internal Storage Capacity

The Survivalink AED will automatically store, internally, up to 20 minutes of ECG and other rescue-event data when no external memory source is available.

If you attempt a second rescue without retrieving or erasing the rescue data in internal memory, upon opening the lid, the voice prompt will say “Data in memory. Do not push ‘Resume’ button until the data is downloaded, unless you must do a rescue.” Survivalink AEDs equipped with an optional text display will display the following: “DATA IN MEMORY” and “PUSH BUTTON TO CLEAR”.

Pressing the “Resume” button will erase the data and allow the rescue attempt to proceed.

Note: Do not press the “Resume” button unless you are sure you want to erase the internal memory in the Survivalink AED.

External Memory Storage

Survivalink AED models 9110/9210 come equipped with a Rescue Data Card slot. Rescue data can be stored on a removable Rescue Data Card. Upon completing the rescue, the card can be removed for data retrieval without taking the Survivalink AED out of use.



The Rescue Data Card stores ECG and other event data. Using MDLink and a Rescue Data Card, the Survivalink AED can record ECG event data along with the ambient sound at the rescue site. The Rescue Data Card has 8 megabytes (MB) of storage memory. The 8 MB card is capable of recording up to ten hours of ECG and event data or up to 40 minutes of voice, ECG and event recording.

Storing and Retrieving Rescue Data

Rescue data recording begins when you do the following:

- Open the lid of the Survivalink AED, and
- Apply the electrodes to the patient's chest

After recording the rescue data, it can be retrieved, stored and printed using a personal computer and RescueLink. See the RescueLink Manual for details.

Inserting a Rescue Data Card Into the Survivalink AED

Insert a blank Rescue Data Card into Survivalink AED's card slot before beginning a rescue. Do this as part of the initial Survivalink AED setup procedure and after each rescue.

To insert the Rescue Data Card:

1. Open the data access door.
2. Insert the Rescue Data Card (arrows side up) by sliding it into the card slot with the arrows pointing toward the Survivalink AED.
3. After firmly seating the Rescue Data Card, close the data access door.

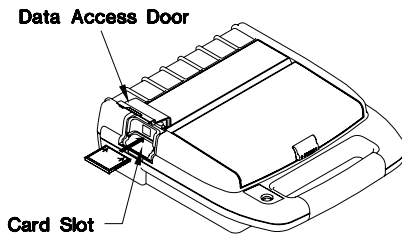

Storing Data on a Rescue Data Card

Rescue Data storage conditions:

- When you insert a blank Rescue Data Card before placing the electrodes on the patient, the rescue data will record on the card.
- If you place the electrodes on a patient with a full Rescue Data Card in the slot, the voice prompt will say, *"Card full. Storing internally,"* and the rescue data will be stored in internal memory of Survivalink AED.
- When the internal memory and the Rescue Data Card are both full, the voice prompt will say, *"Data in memory. Do not push Resume button until data is downloaded, unless you must do a rescue."* Press the "Resume" button to clear the internal memory and continue or insert a blank Rescue Data Card before placing the electrodes.



Transferring Data to a Rescue Data Card

Rescue data can be transferred from the Survivalink AED's internal memory to a blank Rescue Data Card. To transfer the rescue data from internal memory to a rescue data card:

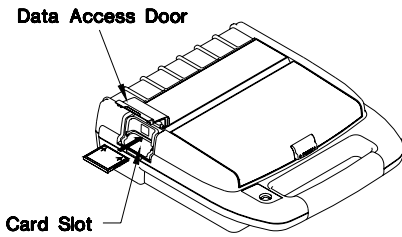

1. Close the Survivalink AED lid.
2. Open the data access door.
3. Insert a blank Rescue Data Card into the card slot.
4. Open the lid.
5. Hold down the "Rescue/Resume" button. When the GREEN "Battery Status" indicators begin to rapidly sequence, the rescue data will transfer from the Survivalink AED's internal memory to the Rescue Data Card. The voice prompt will say, "Program mode".

Note: While transferring data to a rescue card, Survivalink AEDs equipped with the optional text display will display the following: "COPYING DATA TO CARD".



To prevent loss of data, press the "Rescue/Resume" button only while the "Battery Status" indicators are sequencing.

6. When the data transfer is complete, the voice prompt will say, "Card full. Storing internally." Remove the Rescue Data Card from the card slot.
7. Close the lid and data access door.

Retrieving Data From a Rescue Data Card

You can retrieve rescue data from a Rescue Data Card two ways:

- Inserting the Rescue Data Card into a compact flash card reader on a personal computer, or
- Inserting the Rescue Data Card into the Survivalink AED card slot, connecting the Survivalink AED to a PC using the serial communication cable and retrieving the data using RescueLink.

Once the rescue data has been retrieved, erase the Rescue Data Card to prepare for the next rescue.



More information on retrieving and erasing data from a Rescue Data Card is in the RescueLink User Manual.

Section 6 Maintenance & Troubleshooting

Overview

This section presents information about the Survivalink AED diagnostics self-tests, maintenance, and service indications.

Topic	Page
Self-Tests	54
Maintenance	56
Repair Service and Service Indications	58
Indicator Troubleshooting Table	59
Rescue Questions and Answers	60
Diagnostics Questions and Answers	62
Battery Questions and Answers	65

Self-Tests

The Survivalink AED has a comprehensive self-test system that automatically tests, to varying levels, the *electronics, battery, electrodes* and *high voltage circuitry* daily and monthly. Self-tests are also activated every time you open and close the Survivalink AED lid.

Note: On Survivalink AED's equipped with the optional text display, the top line of the display will show the Control Code Version, Prompt Set Identifier and the Text Set Identifier. The bottom line will display the date and time information.

When performing the self-tests, the Survivalink AED completes the following steps automatically:

- Turns itself ON
- Performs the associated self-test
- Turns itself OFF

When a self-test detects an error, a visual and/or audible alert becomes active. By monitoring these visual and audible alerts, you can ensure the Survivalink AED has performed its diagnostics and is ready or unable to conduct a rescue. For the appropriate response to specific alerts, refer to the Troubleshooting Table in this chapter.

When the Survivalink AED is in use, during any scheduled self-test time period, that self-test sequence is postponed 24 hours.

If you open the Survivalink AED lid while the Daily self-tests are in progress, the tests stop and the Survivalink AED begins a normal rescue sequence.

During self-tests, the status indicator will turn RED. Upon successful completion of self-tests, the indicator will turn back to GREEN. There will be no other indication of a self-test in progress.



The self-tests do not eliminate the need for scheduled maintenance.



CAUTION: Temperature/Humidity/Pressure Extremes

Exposing the Survivalink AED, with the battery installed, to extremes outside the following operation and standby conditions will cause the self-tests to be disabled and could cause the Survivalink AED to function

improperly. Storing the Survivalink AED outside these conditions for 5 consecutive days will result in a “service required” alert.

- Temperature 0°C to 50°C (32°F to 122°F)
- Humidity 5% to 95% (non-condensing)
- Pressure 57kPa (+15,000 ft.) to 170kPa (-15,000 ft.)

Daily Self-Test

Every day, at 3:03:03 a.m., the daily self-test occurs; checking the *battery, electrodes, electronics, “Rescue/Resume” button* and the *software*. These components are also tested each time you *open* and *close* the Survivalink AED lid.

Monthly Self-Tests

A *full charge* is discharged internally to test the *high voltage circuitry*. This additional test occurs every 28 days when the daily self-test occurs.

Maintenance

Daily

Perform the following test, daily, to confirm that the Survivalink AED RescueReady diagnostics are functioning properly.

- Check the “Status” indicator to ensure that it is GREEN. When the indicator is GREEN the Survivalink AED is ready for a rescue.
- If the indicator turns RED, refer to the Troubleshooting Table in this chapter.

Performing the Annual Maintenance

Perform the following tests, annually, to confirm that the Survivalink AED RescueReady diagnostics are functioning properly and to verify the integrity of the case.

Verifying the Integrity of the Electrodes and Circuitry

To verify the integrity of the electrodes and circuitry, do the following:

1. Open the Survivalink AED lid.
2. Remove the electrodes.
3. Close the lid.
4. Confirm that the “Status” indicator turns RED. (You must enable the Electrode self-test for this test. Refer to the MDLink manual.)
5. Open the lid and confirm that the “Electrode” indicator is lit.
6. Reconnect the electrodes and close the lid.
7. Verify that the “Status” indicator turns to GREEN.
8. Open the lid and confirm that no diagnostic indicators are lit.
9. Check the expiration date for the electrodes; if expired, replace them.
10. Check the electrode’s packaging integrity.
11. Close the lid.



Verifying the Integrity of the Service Indicator (LED) and Circuitry

To verify the integrity of the service indicator (LED) and circuitry, do the following:

1. Immediately after opening the Survivalink AED lid, press and hold the “Rescue/Resume” button and confirm that the “Service” LED is lit.
2. Release the “Rescue/Resume” button.
3. Close the lid.
4. Verify that the “Status” indicator returns to GREEN.
5. Open the lid and confirm that no diagnostic indicators are lit.
6. Close the lid.

Verifying the Integrity of the Case

Examine the molded case of the Survivalink AED for any visible signs of stress. If the case shows signs of stress, contact Technical Support at one of the following telephone numbers:

(888) 466-8686 (USA only)

(952) 939-4181 (USA and Canada)

+45 44 38 05 39 (International)

Cleaning the Survivalink AED Case

Gently clean the surface of the Survivalink AED case with a damp sponge or with a cloth and mild soap.



CAUTION: Case Cleaning Solutions

When disinfecting the case, use a non-oxidizing disinfectant, such as ammonium salts or a gluteraldehyde based cleaning solution, to avoid damage to the metal connectors.

Verifying the Time Clock

At regular intervals, verify the time on the Survivalink AED using RescueLink. To adjust the internal clock, follow the directions in the RescueLink User Manual.

Repair Service and Service Indications

Authorized Repair Service

The Survivalink AED has no user-serviceable internal components. Try to resolve any maintenance issues with the Survivalink AED by using the Troubleshooting Table presented in this chapter. If you are unable to resolve the problem, contact Cardiac Science Technical Support for repair information at one of the following telephone numbers:

(888) 466-8686 (USA only)

(952) 939-4181 (USA and Canada)

+45 44 38 05 39 (International)



Warning: Shock hazard

Do not disassemble the Survivalink AED! Failure to observe this warning can result in personal injury or death. Refer maintenance issues to Cardiac Science authorized service personnel.







The warranty will be void upon unauthorized disassembly or service of the Survivalink AED.

Service Indications

The Survivalink AED is designed to be reliable and easy to maintain. When the Survivalink AED requires maintenance, the “Status” indicator turns RED and/or an audible maintenance alert will sound. Lift the lid and note which indicator(s) is lit. Use the Troubleshooting Table to determine the maintenance requirement.

Indicator Troubleshooting Table

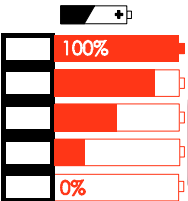
The following is a troubleshooting table for the Survivalink AED indicators.

	Symptom	Solution
	RED "Service" indicator (LED) is lit.	Maintenance by authorized service personnel is required. Call Cardiac Science Technical Support at (888) 466-8686 (USA only), or (952) 939-4181 (USA and Canada), or +45 44 38 05 39 (International).
	RED "Electrodes" indicator (LED) is lit.	Connect the electrodes or replace with a new pair.
	Battery "Replace!" indicator (LED) is RED.	The battery is low. Replace with a new battery.
	"Status" indicator is RED, and no other indicators on the diagnostic panel are lit.	The battery power is completely depleted. Replace with a new battery.

Rescue Questions and Answers

The following table answers frequently asked questions about the **Rescue**:

		Questions and Answers
1.	Q	Can I skip the CPR mode?
	A	No. CPR is a <u>very</u> important part of the optimal resuscitation protocol.
2.	Q	Can I give CPR while the Survivalink AED is analyzing?
	A	No. As with all AEDs, the rescuer should stop CPR compressions during the analysis phase. CPR may interfere with the analysis of the cardiac rhythm.
3.	Q	Can I transport the victim while the Survivalink AED is analyzing?
	A	No. Vehicle motion may cause noise artifacts that could interfere with proper cardiac rhythm analysis. Stop the vehicle when cardiac rhythm analysis is necessary.
4.	Q	When will the Survivalink AED prompt for CPR?
	A	The Survivalink AED will prompt for CPR: <ul style="list-style-type: none">• After the Survivalink AED delivers 3 consecutive defibrillation shocks, or• After the Survivalink AED detects a non-shockable cardiac rhythm during cardiac rhythm analysis, or• When the Survivalink AED detects a shockable cardiac rhythm, but the “Rescue” button is not pushed for approximately 2 1/2 minutes from the placement of electrodes on the patient or after performing CPR
5.	Q	Do I need to prepare the chest prior to electrode application?
	A	No. Special preparation is not usually necessary. However, the chest should be as clean, dry, and as oil free as practical.
6.	Q	How do I know when the electrodes are safe to touch?
	A	The only time energy can be delivered to the electrodes is when the Rescue indicator is flashing, and the Survivalink AED is sounding the charged tone. The electrodes are safe to touch at all other times. However, touching the electrodes during analysis mode may interfere with rhythm analysis.

Rescue Questions and Answers (continued)

		Questions and Answers
7.	Q	What happens if the battery is low when I begin a rescue?
	A	<p>When the “Replace!” indicator is initially lit (when the lid is first opened or at any time during a rescue), the Survivalink AED issues the “<i>Battery Low</i>” prompt <i>once</i>; however, the Survivalink AED is still capable of delivering approximately 9 more defibrillation shocks.</p> <p>When the Survivalink AED <u>is not</u> capable of delivering any more shocks, it <i>continuously repeats</i> the “<i>Battery low</i>” prompt. To continue the rescue attempt, leave the lid open and replace the battery. You must install the replacement battery within 60 seconds to continue the current rescue. When battery replacement takes longer than 60 seconds or the lid is closed, the rescue sequence starts over.</p>
8.	Q	How do I set the Survivalink AED internal clock?
	A	Set the clock by using the RescueLink Software Program and a PC.
9.	Q	What happens if I close the lid in the middle of a rescue attempt?
	A	<p>If you close the lid during a rescue, you must re-open the lid within 15 seconds to continue the rescue. If the lid remains closed for more than 15 seconds, a new rescue will initiate when the lid is re-opened.</p> <p><i>Note: If the lid is closed during a rescue while the electrodes are connected to the patient, the status indicator may turn RED. When the lid is re-opened, however, the rescue may be continued even though the status indicator remains RED.</i></p>

Diagnosics Questions and Answers

The following table answers frequently asked questions about
Diagnosics:

		Questions and Answers
10.	Q	My Survivalink AED is sounding an audible alert. Why? How do I stop it?
	A	The audible alert indicates that the self-test detected a need for maintenance or corrective action. Determine the maintenance required by using the Troubleshooting Table in this chapter. Opening and closing the lid may turn OFF the audible alert until the next self-test. The "Status" indicator, however, will remain RED.
11.	Q	How long will the audible alert sound before the battery is worn down?
	A	A full, Extended Life battery can continue an audible alert for approximately one year.
12.	Q	When I open the lid, why do I get the voice prompt " <i>Data in memory. Do not push 'Resume' button until data is downloaded, unless you must do a rescue?</i> " How do I get the message to stop occurring?

Questions and Answers

	A	<p>This message occurs when there is a previously stored rescue in the internal memory of the Survivalink AED <u>AND</u>:</p> <p>The Rescue Data Card memory is full; or</p> <p>The Rescue Data Card is not inserted</p> <p>You can clear the message by:</p> <ol style="list-style-type: none"> 1. Inserting a blank Rescue Data Card and transferring the rescue data from the internal memory of the Survivalink AED to the Rescue data card and erasing the stored rescue data (do this if the message does not occur during a rescue attempt) 2. Downloading the rescue data with RescueLink and erasing the stored rescue data 3. Pressing the “Rescue/Resume” button to erase the internally stored rescue data 4. Replacing a full Rescue Data Card with an empty one (do this when the message occurs during a rescue attempt)
13.	Q	<p>When I open the lid, why do I get the voice prompt “<i>Card full. Storing internally?</i>”</p>
	A	<p>There is a previous rescue in the optional Rescue Data Card, and the rescue data from the current rescue will be stored in the internal memory of the Survivalink AED.</p> <p>An invalid card (other than the Rescue Data Card) can also cause this prompt.</p>

Diagnostics Questions and Answers (continued)

		Questions and Answers
14.	Q	The Survivalink AED did not sound an audible alert when I removed the electrodes and closed the lid. Why?
	A	Missing electrodes or a low battery will only trigger the audible maintenance indicator after the Daily self-test. The lid-closed self-test only activates the “Status” indicator, providing the rescuer with time to replace the electrodes after a rescue without triggering the audible alert.
15.	Q	How many defibrillation shocks can I deliver when the “Replace!” indicator is lit?”
	A	Survivalink AED can deliver approximately 9 defibrillation shocks from the time the indicator is initially lit. However, you should replace the battery as soon as possible. If you must replace the battery during a rescue, you have one minute to replace the battery or a new rescue will begin.
16.	Q	Why do I get the voice prompt “ <i>Press flashing button to continue rescue</i> ” when I open the lid? How do I get the message to stop?
	A	Several conditions may initiate this prompt; including cold, soiled or expired electrodes. <ul style="list-style-type: none">• If the prompt occurs while the electrodes are on the patient, push the “Rescue/Resume” button and continue with the rescue.• If the prompt occurs and the electrodes are in the package, remove the electrodes, place them on the patient and press the “Rescue/Resume” button to continue the rescue.• If the electrodes are soiled, expired, or damaged, replace the electrodes with a new pair, place them on the patient and press the “Rescue/Resume” button to continue the rescue.• If a rescue is not in progress, plug in a pair of room temperature packaged electrodes and the voice prompt should stop.

Battery Questions and Answers

The following table answers frequently asked questions about the **battery**:

		Questions and Answers
17.	Q	When is the battery considered low?
	A	The battery is considered low when the “Replace!” indicator is lit and there are approximately 9 more defibrillation shocks remaining.
18.	Q	If I have a spare battery for my Survivalink AED, should I rotate the batteries?
	A	No. Replace the battery when the “Replace!” indicator is lit.
19.	Q	Is there a volume adjustment for the voice prompt?
	A	No. The volume level is preset at the factory.
20.	Q	What can I do to keep the Survivalink AED warm when a rescue is in an isolated area and at subzero temperatures?
	A	When travel to a rescue involves exposing the Survivalink AED to extremely cold temperatures for an extended period of time (as with a snowmobile), keep the electrodes and the battery warm by removing them from the Survivalink AED and placing them inside your coat.

AED OUTLET

Technical Data

Overview

This section presents technical data about the Survivalink AED.

Topic	Page
Parameters	68
Safety and Performance Standards	72
Clinical Study Summary	81

Parameters

Operation

Semi-automatic (shock advisory)

Audible Alerts

Voice prompt

Charged tone

Maintenance alert

Card insert alert

Visible Indicators

Status indicator

Battery status indicators

Service indicator

Electrodes indicator

Optional Text Display

Rescue Data Storage

Storage	Capacity
Internal	20 minutes ECG data with event annotation
External (Removable)	With 8 MB (minimum) Rescue Data Card option: <ul style="list-style-type: none">• 40 minutes ECG with voice and event annotation• Ten hours continuous ECG data with event annotation

Dimensions

Measurement	Dimension
Height	8 cm (3.3 in)
Width	27 cm (10.6 in)
Depth	31 cm (12.4 in)

Weight

Model	Weight with Batteries and Electrodes
9100	3.36 kg (7.4 lb)
9110	3.41 kg (7.5 lb)
9200	3.50 kg (7.7 lb)
9210	3.55 kg (7.8 lb)

Operation and Standby Conditions

Atmosphere	Condition
Temperature	0°C to +50°C (32°F to +122°F)
Humidity	5% to 95% (non-condensing)
Pressure	57kPa (+15,000 ft) to 170kPa (-15,000 ft)

Shipment and Transport Conditions (for up to 1 week)

Atmosphere	Condition
Temperature	-40°C to +65°C (-40°F to +149°F)
Temperature W/Display	-30°C to 65°C (-22°C to 149°F)

Atmosphere	Condition
Humidity	5% to 95% (non-condensing)
Pressure	58kPa (+15,000 ft) to 170kPa (-15,000 ft)

Electrodes

ANSI/DF-39 (1993)

- Self-adhesive, disposable defibrillation electrodes
- Minimum combined surface area: 228 cm²
- Extended length of leadwire: 1.0 m - 1.3 m

Lithium Battery Output Voltage and Extended Life

- Output Voltage for standard and extended life: 12VDC (max.)
- Extended life batteries are disposable and non-rechargeable
- Lithium contents: 13.2g (max.)

Battery	Expected Operating Life	Expected Shelf Life	Typical Charges (at 20°C)	Maximum Charges (at 20°C)
9141 Extended Life Lithium	5-years	5-years	300	365

Batteries and Capacitor Charge Times

A fully charged battery typically takes 11 seconds to charge a fully discharged Survivalink AED to its maximum energy.

The Survivalink AED typically takes 11 seconds to charge to its maximum energy after 15 maximum energy charges.

A battery, with reduced capacity that causes the “Replace” indicator to initially turn ON, typically takes 13 seconds to charge a fully discharged Survivalink AED to maximum energy.

The maximum time from “Power On” to “Ready to Shock” is 28 seconds.

The maximum time from “Analyze” to “Ready to Shock” is 22 seconds.

Delivery of Three Defibrillation Shocks

55 seconds (nominal)

Survivalink AED Self-Test Sequence

Frequency of Self-Test	What is Tested
Daily	Battery, electrodes, internal electronics, rescue/resume button and software
Monthly (every 28 days)	Battery under load, electrodes, internal electronics, full-energy charge cycle, rescue/resume button and software

AED OUTLET

Safety and Performance Standards

Survivalink AED Models 9100/9110 & 9200/9210

The Survivalink AED has been designed and manufactured to conform to the highest standards of safety and performance including electromagnetic compatibility (EMC). The Survivalink AED Models 9100/9110 and 9200/9210 and electrodes conform to the applicable requirements of the following:

Classification

IEC 601-1, defibrillator-proof type BF patient connection, internally powered only, continuous operation, IP23 & not suitable for use in the presence of flammable anesthetic mixture with air or with oxygen or nitrous oxide.

The device output has been tested and found to withstand the effects of another defibrillator without damage.



CE

CE Marked by TUV Product Services 0123 per the Medical Device Directive 93/42/EEC of the European Nations



UL and cUL

Classified by Underwriters Laboratories Inc. with respect to electric shock, fire and mechanical hazards only in accordance with UL 2601-1 and IEC 601-2-4, IEC SC 62D/WG2 (O'Dowd) and CAN/CSA C22.2 No.601.1-M90 and 45JF

Electrical, Construction, Safety and Performance

IEC 601-1 (1988), Amendments 1 (1991) & 2 (1995)
IEC 601-2-4, 2nd Edition, (IEC SC 62D/WG2 O'Dowd 97/08)
ANSI/AAMI DF-39 (1993)

Electromagnetic Compatibility (EMC)

IEC 601-1-2 (1993)
ANSI/AAMI DF-39(1993) Section 3.3.21

Emissions

Field	Models	Standard or Compliance
E-M	9100/9110	EN 55011/C.I.S.P.R. 11, Group 1, Category B RTCA/DO-160D, Section 21, Category L (Category B during charging) RTCA/DO-199, Section 6.2.2
	9200/9210	
Magnetic	9100/9110	AAMI DF39, < 0.5mT on surface, except for within 5cm of the lid magnet and the speaker RTCA/DO-160D, Section 15, Category Z
	9200/9210	

Immunity

Field	Models	Standard or Compliance
E-M	9100/9110	IEC 801-3 (1984), Level 3
	9200/9210	EN 61000-4-3, Level 3
Magnetic	9100/9110	MIL-STD-462D, Method RS101
	9200/9210	EN 61000-4-8, 80A/m for 47.5Hz - 1320Hz
ESD	9100/9110	IEC 801-2 (1991), Level 2
	9200/9210	EN 61000-4-2, Level 2

Environmental Conditions

Condition	Models	Standard or Compliance
Temperature/ Altitude/ Decompression/ Overpressure	9100/9110 9200/9210	RTCA/DO-160D, Section 4, Category A4, Operating: 0°C to 50°C, Ground Survival: 0°C to 50°C
Temperature Variation	9200/9210	RTCA/DO-160D, Section 5, Category C
Free Fall Drop	9100/9110 9200/9210	IEC 68-2-32 (1975), 1 meter
Shock (Bump)	9100/9110	IEC 68-2-29, 25g and 6000 bumps
	9200/9210	IEC 68-2-29, 40g and 6000 bumps
Vibration (Random)	9100/9110 9200/9210	RTCA/DO-160D, Section 8, Category S
	9200/9210	IEC 68-2-64: 10Hz - 2kHz at 0.0500 - 0.0012 g ² /Hz
Vibration (Sine)	9100/9110	IEC 68-2-6: 10Hz - 40.7Hz at 0.15 mm and 40.7Hz - 150Hz at 1g
	9200/9210	IEC 68-2-6: 10Hz - 57.6Hz at 0.15 mm and 57.6Hz - 150Hz at 2g
Enclosure Protection	9100/9110 9200/9210	IEC 529, IP23

Shipping and Transport Conditions

ASTM D4169-92

Survivalink AED Models 9100/9110 Waveform

AAMI DF-2 (1996), Section 4.3.4.2, truncated exponential

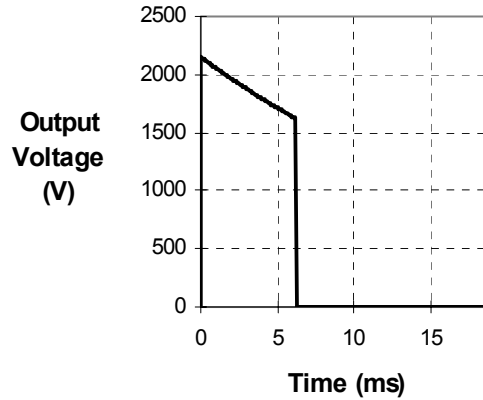

200 Joule Survivalink AED Models 9100/9110 Waveform (all values are typical)

Patients' Impedance (Ohms)	Voltage (Volts)	Duration (ms)
25	1900	3.0
50	1900	4.0
75	1900	6.1
100	1900	8.1
125	1900	10.1

300 Joule Survivalink AED Models 9100/9110 Waveform (all values are typical)

Patients' Impedance (Ohms)	Voltage (Volts)	Duration (ms)
25	2000	3.5
50	2000	6.9
75	2000	10.4
100	2000	13.9
125	2350	9.8

360 Joule Survivalink AED Models 9100/9110 Waveform (all values are typical)

Patients' Impedance (Ohms)	Voltage (Volts)	Duration (ms)
25	2000	5.8
50	2000	11.5
75	2000	17.3
100	2000	23.0
125	2350	13.2

Energy Levels and Patient Impedance

The Survivalink AED Monophasic Truncated Exponential (MTE) waveform has energy levels of 200 J, 300 J, 360 J ($\pm 15\%$) at 50 Ohms patient impedance. This allows for escalating energies of subsequent shocks. The automatic waveform correction for patient impedance is shown in the preceding Survivalink AED Models 9100/9110 Waveform tables.

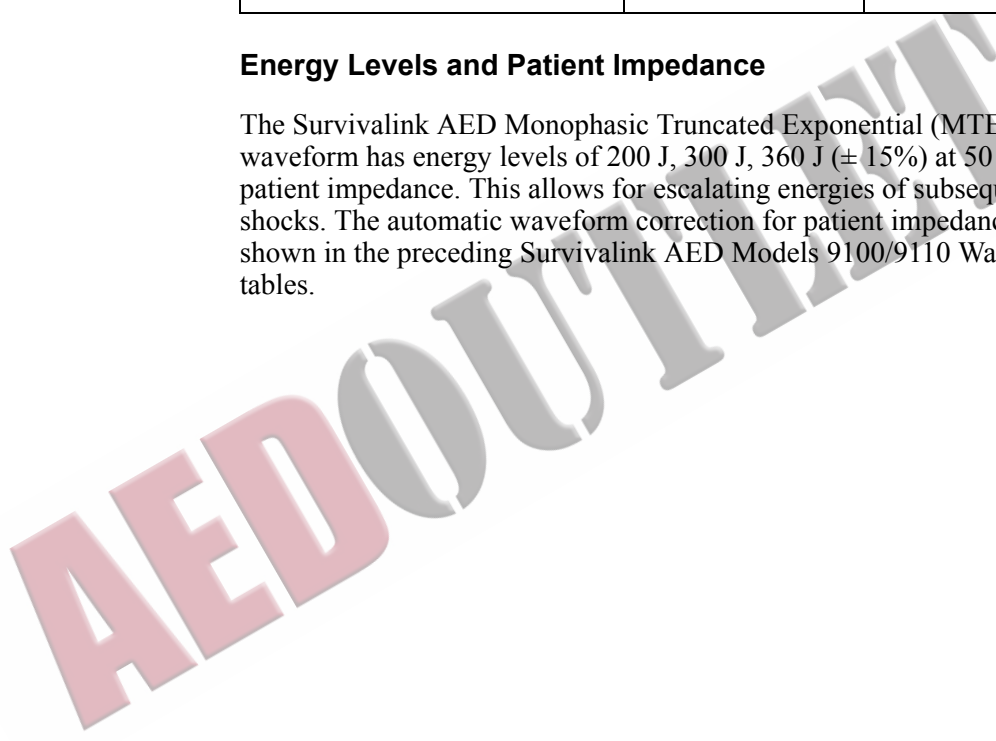

Survivalink AED Models 9200/9210 Waveform

AAMI DF-2 (1996), Section 4.3.4.3, other waveforms

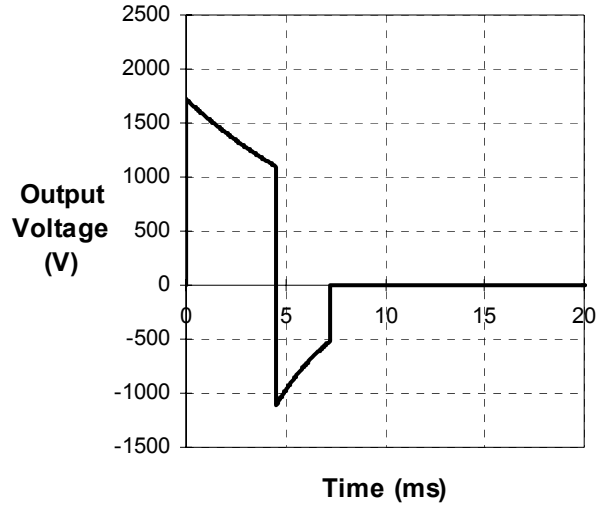

Low Current Survivalink AED Models 9200/9210 Waveform (all values are typical)

Patient's Impedance (Ohms)	Phase 1		Phase 2		Energy (Joules)
	Voltage (Volts)	Duration (ms)	Voltage (Volts)	Duration (ms)	
25	1570	3.3	825	3.2	180-250
50	1600	4.5	1031	3.2	170-220
75	1620	5.8	1111	3.2	150-210
100	1630	7.0	1158	3.2	140-190
125	1650	8.3	1193	3.2	140-190

High Current Survivalink AED Models 9200/9210 Waveform (all values are typical)

Patient's Impedance (Ohms)	Phase 1		Phase 2		Energy (Joules)
	Voltage (Volts)	Duration (ms)	Voltage (Volts)	Duration (ms)	
25	1890	3.3	993	3.2	270-360
50	1920	4.5	1238	3.2	240-320

Patient's Impedance (Ohms)	Phase 1		Phase 2		Energy (Joules)
	Voltage (Volts)	Duration (ms)	Voltage (Volts)	Duration (ms)	
75	1930	5.8	1324	3.2	220-290
100	1940	7.0	1379	3.2	200-270
125	1950	8.3	1410	3.2	190-260

Energy Levels and Patient Impedance

The Survivalink Biphasic Truncated Exponential (BTE) waveform utilizes variable energy¹. The precise energy delivered will vary with the patient's impedance. Energy will be delivered at two different levels referred to as low current and high current as shown in the preceding Survivalink AED Models 9200/9210 Waveform tables. This allows for escalating energies of subsequent shocks.

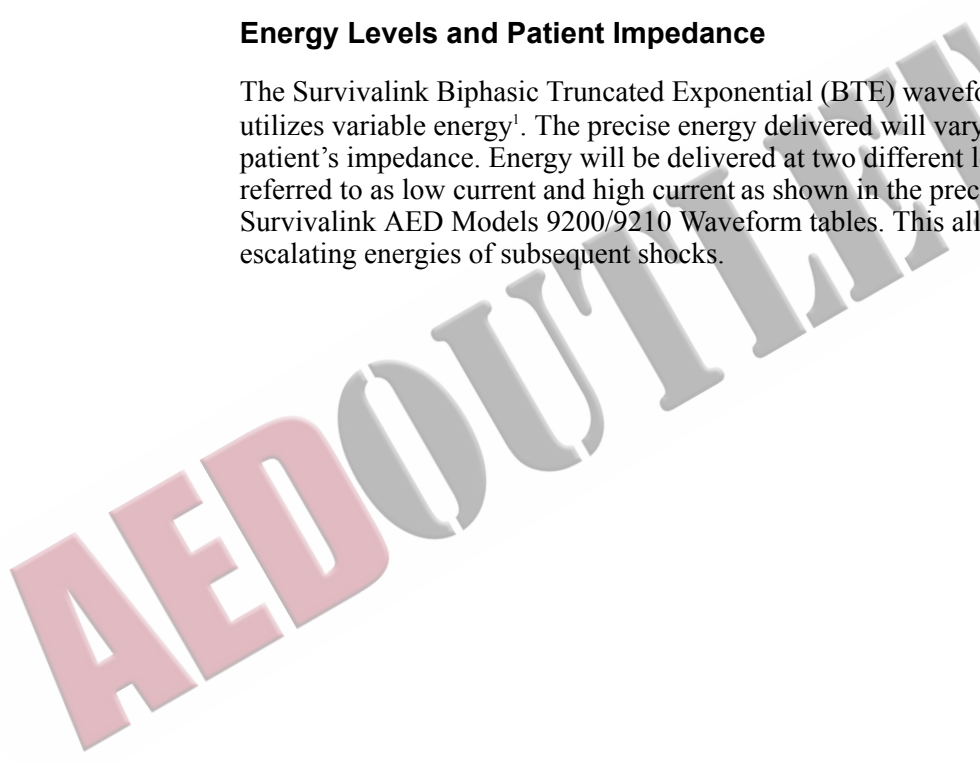

1. Survivalink AED Models 9200/9210: The low current and high current shocks are variable energy. The actual energy is determined by the patient's impedance.

Rhythm Recognition Detection System

The Survivalink AED Rhythm Recognition Detection system analyzes the patient's ECG and advises you when the Survivalink AED detects a shockable or non-shockable rhythm.

This system makes it possible for a person, with no training in the interpretation of ECG rhythms, to offer defibrillation therapy to victims of ventricular fibrillation, pulseless ventricular tachycardia, or pulseless supraventricular tachycardia.

The Survivalink AED Rhythm Recognition Detection System contains:

- Electrode contact determination
- Automated interpretation of the ECG
- Operator control of defibrillation shock therapy

The transthoracic impedance of the patient is measured through the defibrillation electrodes. When the baseline impedance is higher than a maximum limit, the Survivalink AED determines that the electrodes are not in sufficient contact with the patient or are not properly connected to the Survivalink AED. ECG analysis and defibrillation-shock delivery are therefore inhibited. The voice prompt will say, "*Check Electrodes*" when electrode contact is inadequate.

Automated Interpretation of the ECG

The Survivalink AED Rhythm Recognition Detection System is designed to recommend a defibrillation shock when placed on a patient who is unconscious, not breathing and has no pulse, when it detects:

- Ventricular fibrillation - when peak to peak amplitude is greater than asystole threshold (0.15 mV nominal) and cardiac rhythm rate of at least 180 bpm
- Ventricular tachycardia - cardiac rhythm rate is at least 180 bpm
- Supraventricular tachycardia² - cardiac rhythm rate is at least 180 bpm

The Survivalink AED Recognition Detection System will not recommend a defibrillation shock for all other ECG rhythms that do not meet these criteria, including Asystole and normal sinus rhythms.

ECG analysis is performed on a 9 second sample of ECG.

Operator Control of Defibrillation Shock Delivery

The Survivalink AED Recognition Detection System causes the Survivalink AED to automatically charge when the Survivalink AED detects a shockable cardiac rhythm. Audio and visual prompts are used to

2. Defibrillation. In: Cummins R, ed. *Advanced Cardiac Life Support*: American Heart Association; 1997:4-9.

advise you that the Survivalink AED recommends a defibrillation shock. When a defibrillation shock is advised, you determine if or when to deliver the shock.

Cardiac Rhythms Used to Test the Rhythm Recognition Detection System for Survivalink AED Models 9100/9110

Rhythm Class	Models	ECG Test Sample Size ^a	Specifications
Shockable Rhythm - VF	9100/9110	304	Survivalink AED meets the AAMI DF39 requirement and AHA recommendation ^b of Sensitivity > 90%.
	9200/9210	318	
Shockable Rhythm - VT	9100/9110	12	Survivalink AED meets the AAMI DF39 requirement and AHA recommendation ^b of Sensitivity > 75%.
	9200/9210	53	
Non-shockable rhythm - Normal Sinus Rhythms	9100/9110	1082	Survivalink AED meets the AAMI DF39 requirement of Specificity > 95% and AHA recommendation ^b of Specificity > 99%.
	9200/9210	1207	
Non-shockable rhythm - Asystole	9100/9110	10	Survivalink AED meets the AAMI DF39 requirement and the AHA recommendation ^b of Specificity > 95%.
	9200/9210	16	
Non-shockable rhythm - all other non-shockable rhythms	9100/9110	1729	Survivalink AED meets the AAMI DF39 requirement and AHA recommendation ^b of Specificity > 95%.
	9200/9210	2363	

a. From Survivalink ECG rhythm databases.

b. Automatic External Defibrillators for Public Access Defibrillation: Recommendations for Specifying and Reporting Arrhythmia Analysis Algorithm Performance, Incorporating New Waveforms, and Enhancing Safety, American Heart Association (AHA) AED Task Force and approved by the AHA Science Advisory and Coordinating Committee, 3/18/97, Table 2.

Clinical Study Summary

Comparison of Survivalink's Biphasic and Monophasic Truncated Exponential Waveforms

An IDE Clinical Study was performed. The first shock efficacies of the control Monophasic truncated exponential waveforms were compared to the first shock efficacy of the Biphasic truncated exponential waveforms.

The study was divided into two sections. The first section was a low energy section comparing a 200J (low energy) Monophasic versus a 200J³ (low current) Biphasic. The second section was a high energy section comparing a 360J (high energy) Monophasic versus a 300J (high current) Biphasic. Each section was a prospective, randomized, blinded, study designed with an independent group of patients for each section. All patients undergoing procedures for electrophysiological testing or implantation of ICDs were invited to enroll in the study.

A total of 115 first shocks were delivered for both the Monophasic and Biphasic waveforms. Of the 115 first shock attempts, 60 were in the low energy arm and 55 in the high energy arm. There were no adverse events associated with any of the treatments.

TABLE 1. Defibrillation Rate of Survivalink's Monophasic and Biphasic Waveforms

	Monophasic Waveform	Biphasic Waveform	Statistical Analysis
Overall First Shock Success; n = 115 (95% Confidence Interval)	97.4% (94.5% - 100%)	100% (100%)	p = 0.0001**
Low Energy First Shock Success; n =604 (95% Confidence Interval)	96.7% (92.2% - 100%)	100% (100%)	p = 0.002**
High Energy First Shock Success; n = 55 (95% Confidence Interval)	98.2% (94.7% - 100%)	100% (100%)	p = 0.0001**

** highly statistically significant

3. Survivalink AED Models 9200/9210: The low current and high current shocks are variable energy. The actual energy is determined by the patient's impedance.

Clinical Study Conclusion

The overall efficacy rate of Survivalink's Biphasic waveform is equivalent to the overall efficacy rate of Survivalink's Monophasic waveform.

The efficacy rates of the stacked shock sequence of Survivalink's Biphasic waveform are equivalent to the Survivalink AED Monophasic waveform stacked shock sequence.

- Monophasic stacked shock sequence: 200J, 300J, 360J is equivalent to the Biphasic 200J, 300J, 300J² stacked shock sequence
- Monophasic stacked shock sequence: 360J, 360J, 360J is equivalent to the Biphasic 300J, 300J, 300J² stacked shock sequence

AED OUTLET

Parts & Software

Overview

This section presents standard and optional parts and software for the Survivalink AED. To place an order, call Cardiac Science customer service at (800) 991-5465 or (952) 939-4181. Fax: (952) 939-4191.

Topic	Page
Standard Parts and Software	84
Optional Parts and Software	85

Standard Parts and Software

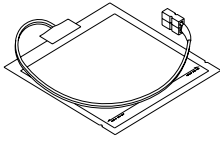

Defibrillation Electrodes

Model 9130 Two-Year Defibrillation Electrodes

Model 9610 One-Year Pacing/Monitoring/Defibrillation Electrodes

The adhesive-backed electrodes, with an attached cable and connector, come in a sealed package ready-to-use.

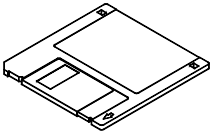

RescueLink Software Program

This software allows you to transfer, view, and store rescue data recorded by the Survivalink AED. You can transfer the data from the Survivalink AED to your personal computer where you can print out the data. You can also set the Survivalink AED's internal clock using this software.

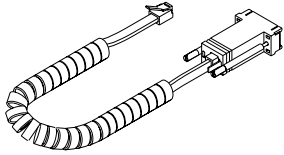

Serial Communication Cable

This cable connects the Survivalink AED to your PC for downloading rescue data. The gray nine-pin connector plugs into the PC and the other end plugs into the Survivalink AED.

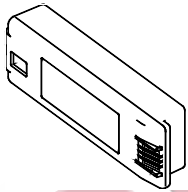

Model 9141 IntelliSense Extended Life Battery

This extended life battery (installed in Survivalink AED) operates for up to 5 years in Standby mode, or can typically deliver 300 shocks before requiring replacement.

Optional Parts and Software

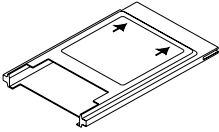

PCMCIA Card Adapter

This adapter permits the use of a compact flash card in the type two or type three, PCMCIA readers.



Rescue Data Storage Card

Survivalink AED models 9110/9210 come equipped with a Rescue Data Card slot; you can store the rescue data on a removable Rescue Data Card. Upon completing the rescue, you can remove the card for data retrieval without taking the Survivalink AED out of use.

The Rescue Data Card stores ECG and other event data. Using the MDLink Options Software and a Rescue Data Card, you can program the Survivalink AED to record ECG event data along with the ambient sound at the rescue site. The Rescue Data Card has eight megabytes (MB) of storage memory and is capable of recording up to ten hours of ECG and event data, or up to 40 minutes with voice recording.

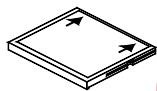

MDLink Options Card

This card can be programmed with default and selectable software settings used to change the operation of the Survivalink AED using MDLink.

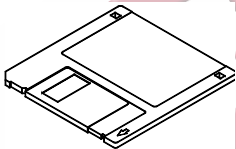

MDLink

This program allows you to select several operating parameters and define identifiers for the Survivalink AED and its associated battery packs.

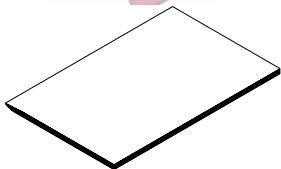

MDLink Manual

This manual explains how to install and use the MDLink software.

AED OUTLET